



VIRTUOSO

MODERN HOME SYSTEMS

Aluminum cantilever gate

Poarta cantilever din aluminiu

5.9m

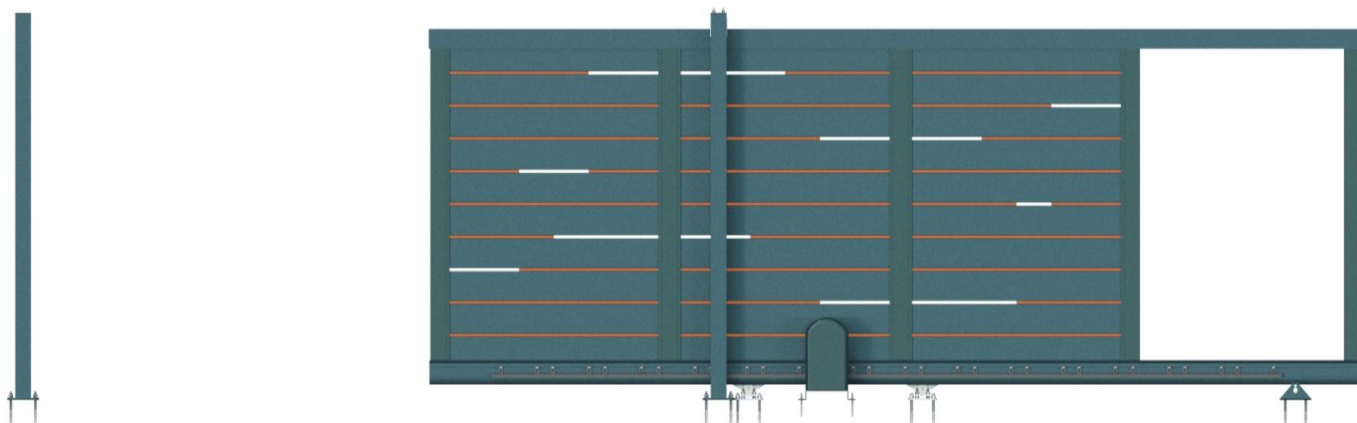

EN	Assembly instructions and information to read and keep.....	1
RO	Instrucțiuni de asamblare și informații de citit și păstrat.....	12

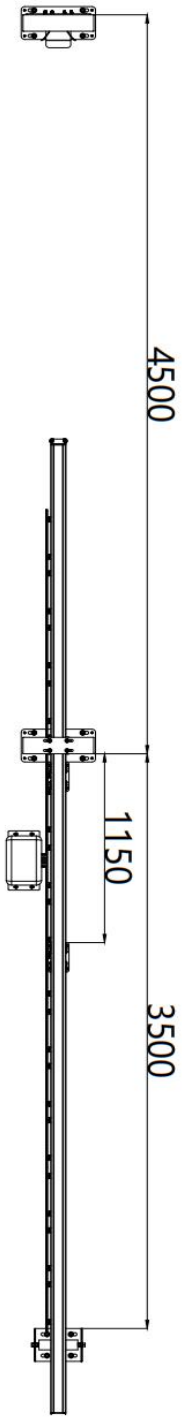
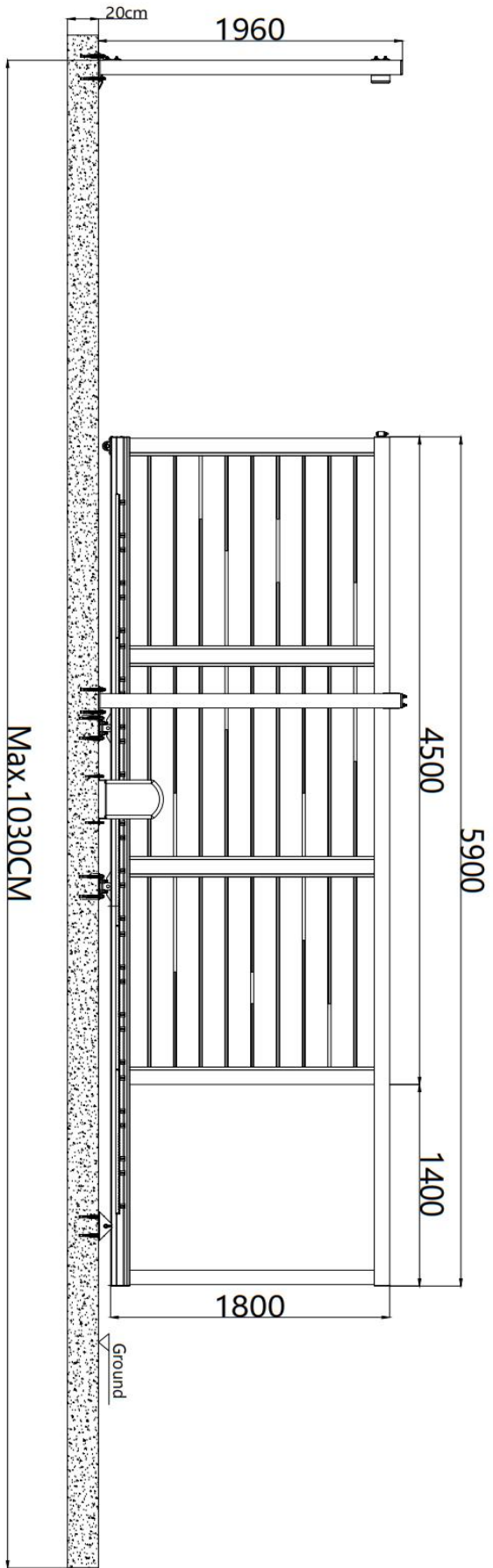

Contents

Introduction

I. Dimensions

II. Necessary tools

III. Assembly guide

1. List of parts

2. Assembly Instructions

IV. After-sales service and guarantees

INTRODUCTION

This portal is designed for domestic use to the exclusion of any residential or business use.

SAFETY, ENVIRONMENTAL AND LEGISLATION INSTRUCTIONS

SAFETY AND ENVIRONMENTAL INSTRUCTIONS

FAILURE TO FOLLOW CEMANUEL WARNINGS CAN CAUSE VERY SERIOUS INJURY AND/OR DAMAGE TO THE GATE.

To make the safety instructions easier to understand, the following symbols are used in this manual:



This WARNING symbol indicates actions or behaviors that could lead to a dangerous situation or to contact with dangerous organs which could cause very serious injury.



This 'CAUTION' symbol indicates important points which could lead to damage to the gate if not respected.

CHECKS AND ADVICE BEFORE ASSEMBLY



- Consult the instructions before any assembly.
- Check using the instructions that all the parts are present.
- In the event of missing or damaged parts, contact Virtuoso after-sales service before carrying out assembly.
- Arrange the parts before assembly by arranging the work space to facilitate assembly.
- Do not mount the gate on a windy day.
- Make sure there is enough space for the doors to open.
- Assembly preferably requires 2 people with good DIY knowledge

SECURITY



In order to mount your gate safely, use the following personal protective equipment:



Noise canceling headphones



Gloves



Shoes



Glasses

I.DIMENSIONS

Gate length:590cm

Gate height: 180cm-200cm

Minimum space between posts: 450cm

Minimum post height: 196cm-216cm

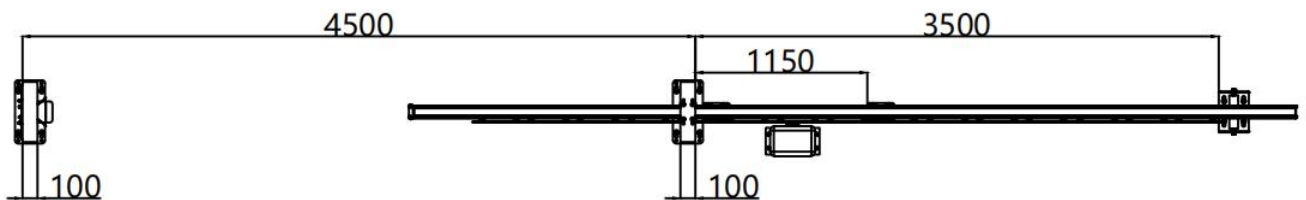

ATTENTION

If you wish to motorize your gate, it is imperative to take into account the specifics of motorization installation in the positioning of your gate and this before installing your gate.

I.DIMENSIONS

POSITIONING OF THE REINFORCED BLADE:

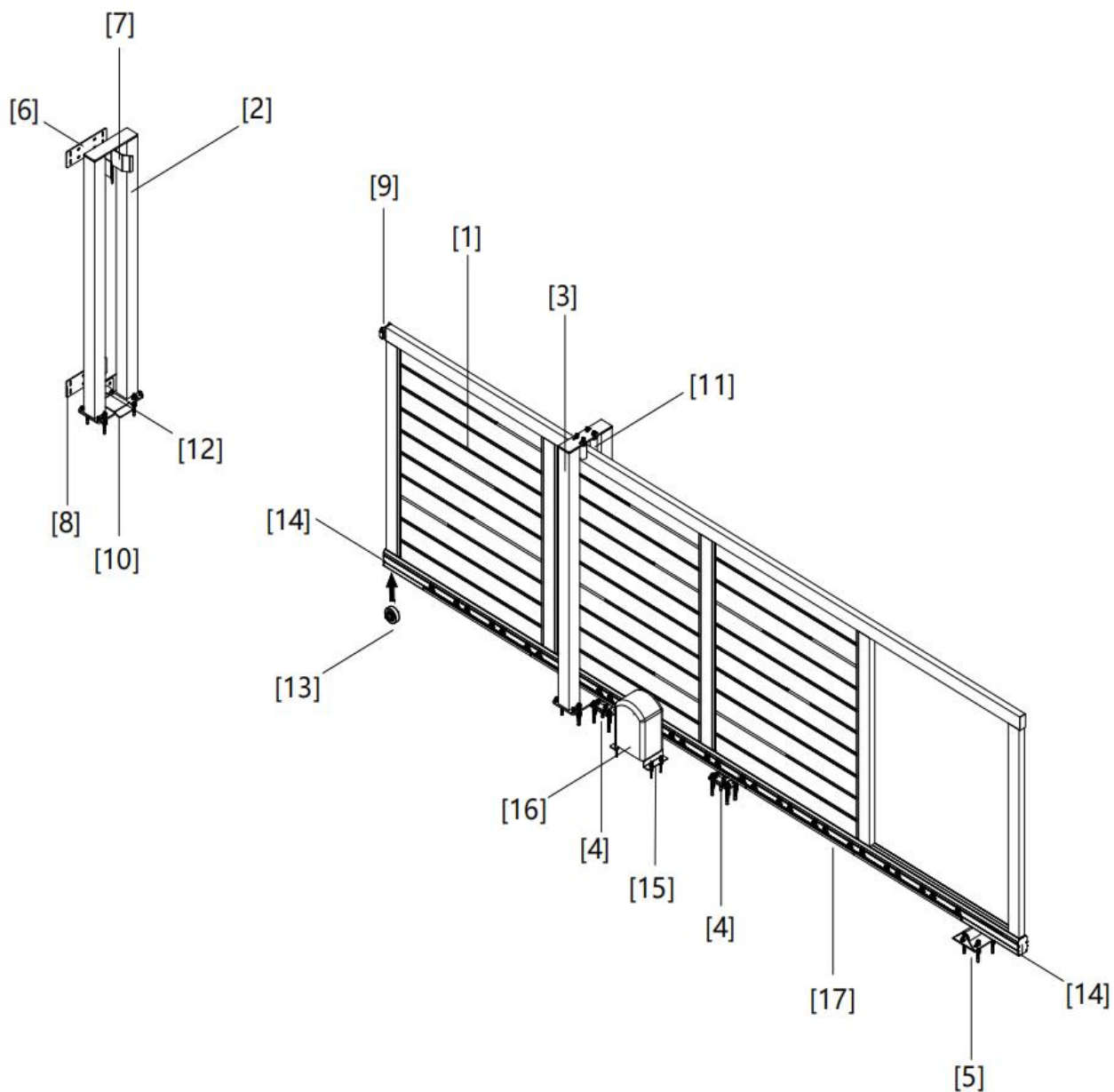

II.Necessary tools

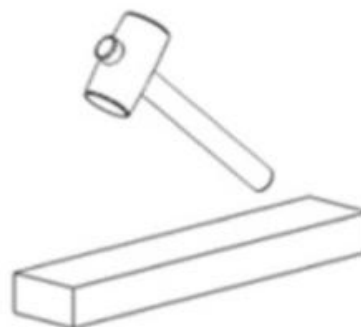
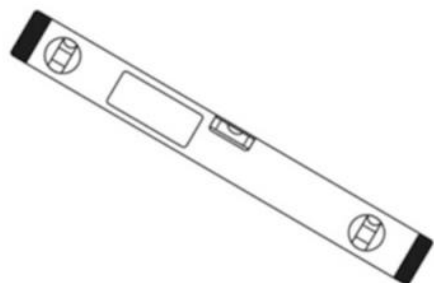
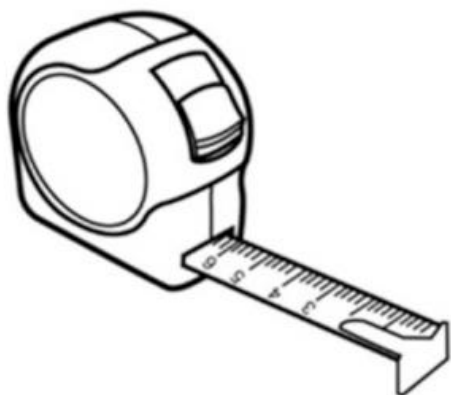

III.Assembly guide

1.PART LIST

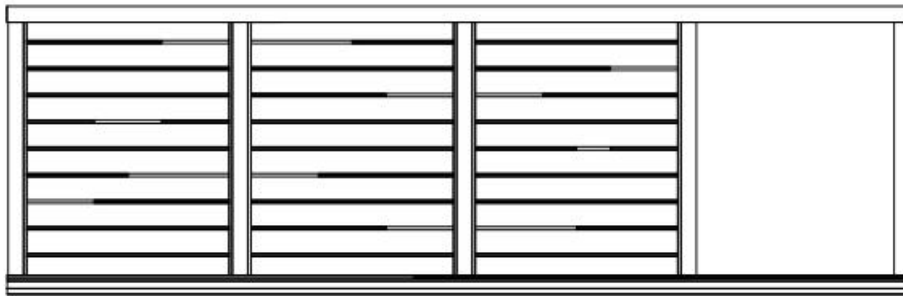

[1]

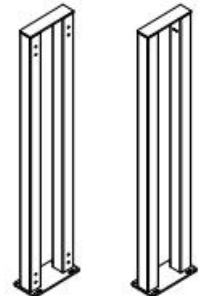

[2]

[3]



[4]-2



[5]

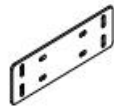

[6]



[7]-2



[8]



[9]



[10]



[11]-4



[12]



[13]



[14]-2



[15]



[16]



[17]



[18]-20
M16×150



[19]-8
M10×40



[20]-20
M10×30



[21]-5
M8×30



[22]-30
M6×16



[23]-8
M5×15



[24]-4
M10×120

2.Assembly Instructions

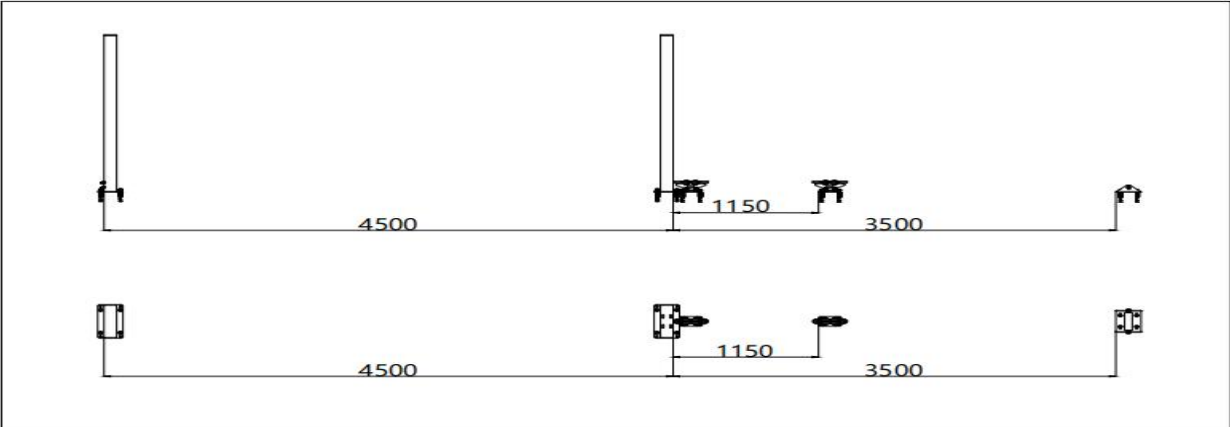
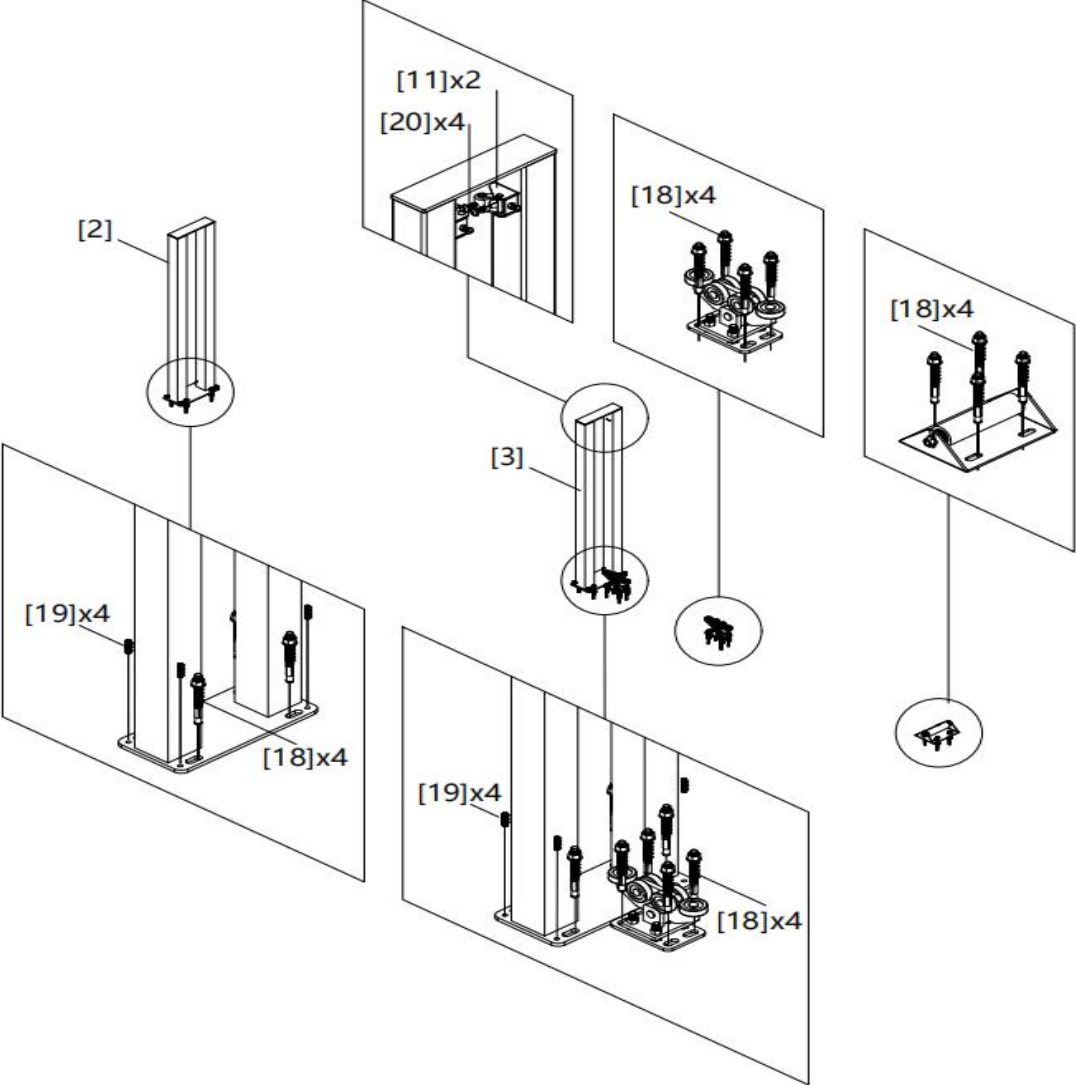

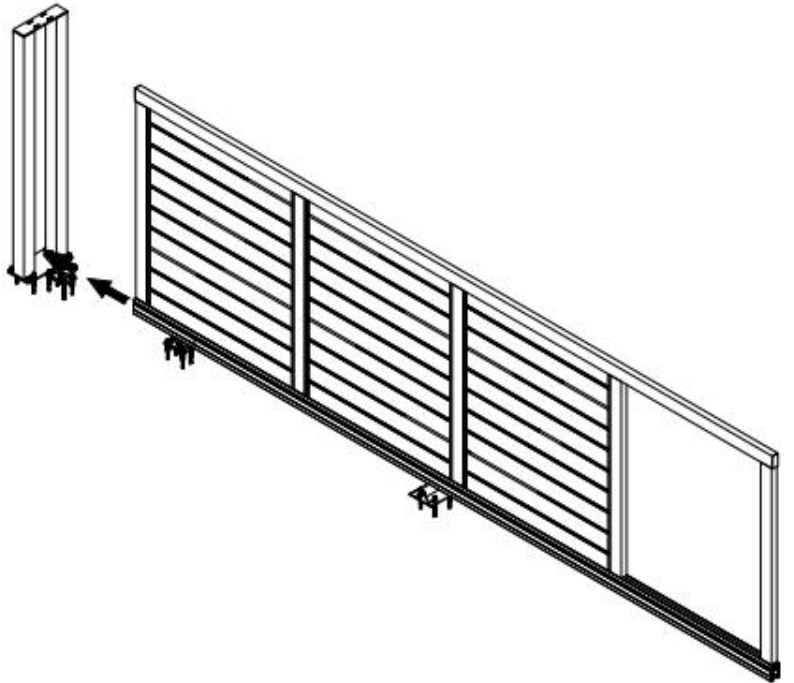
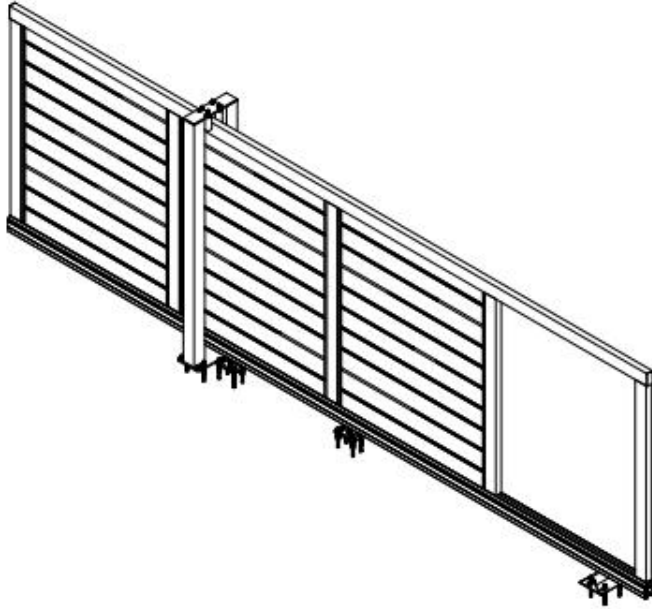
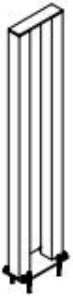
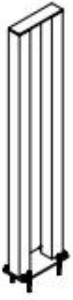

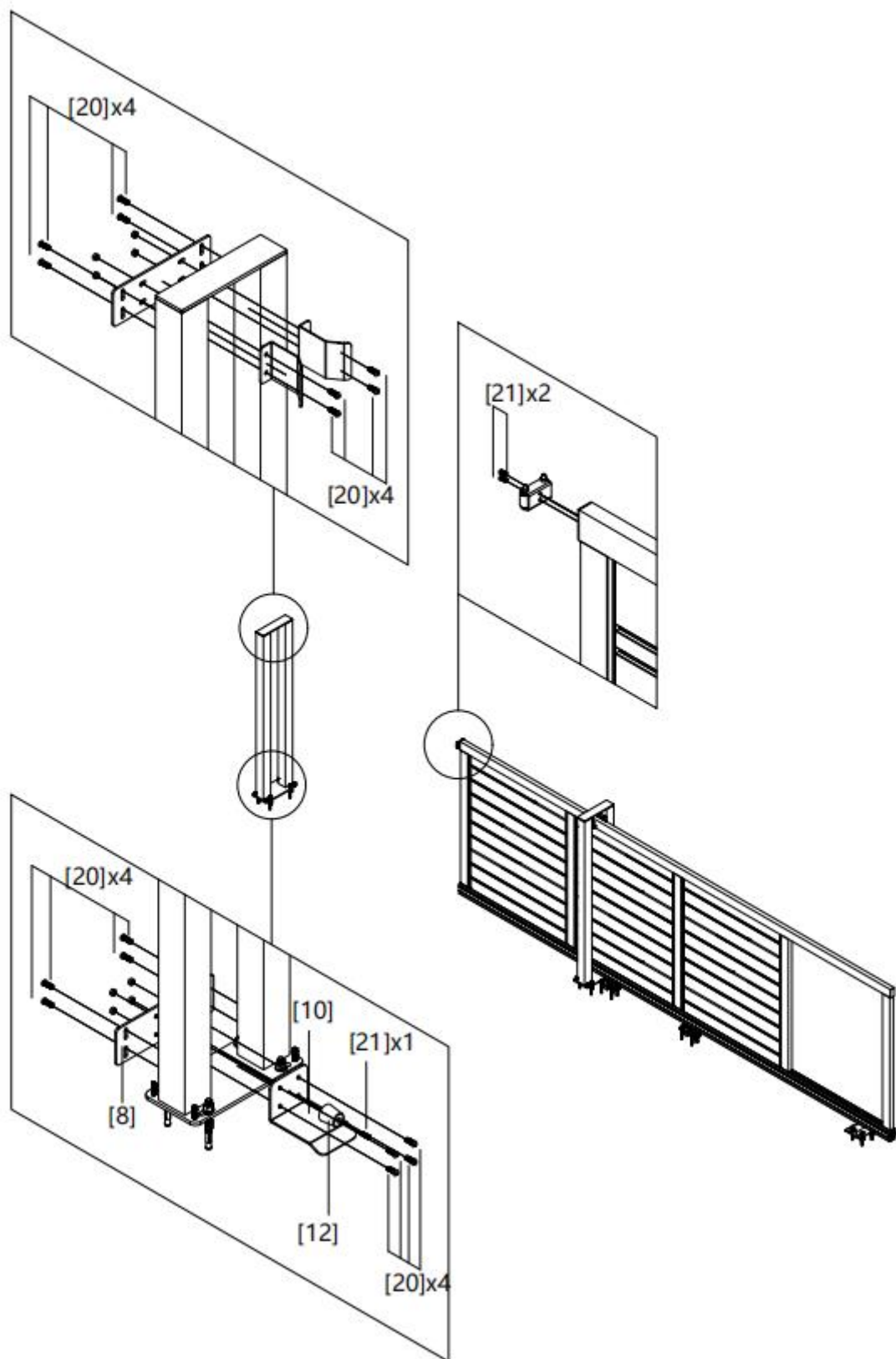

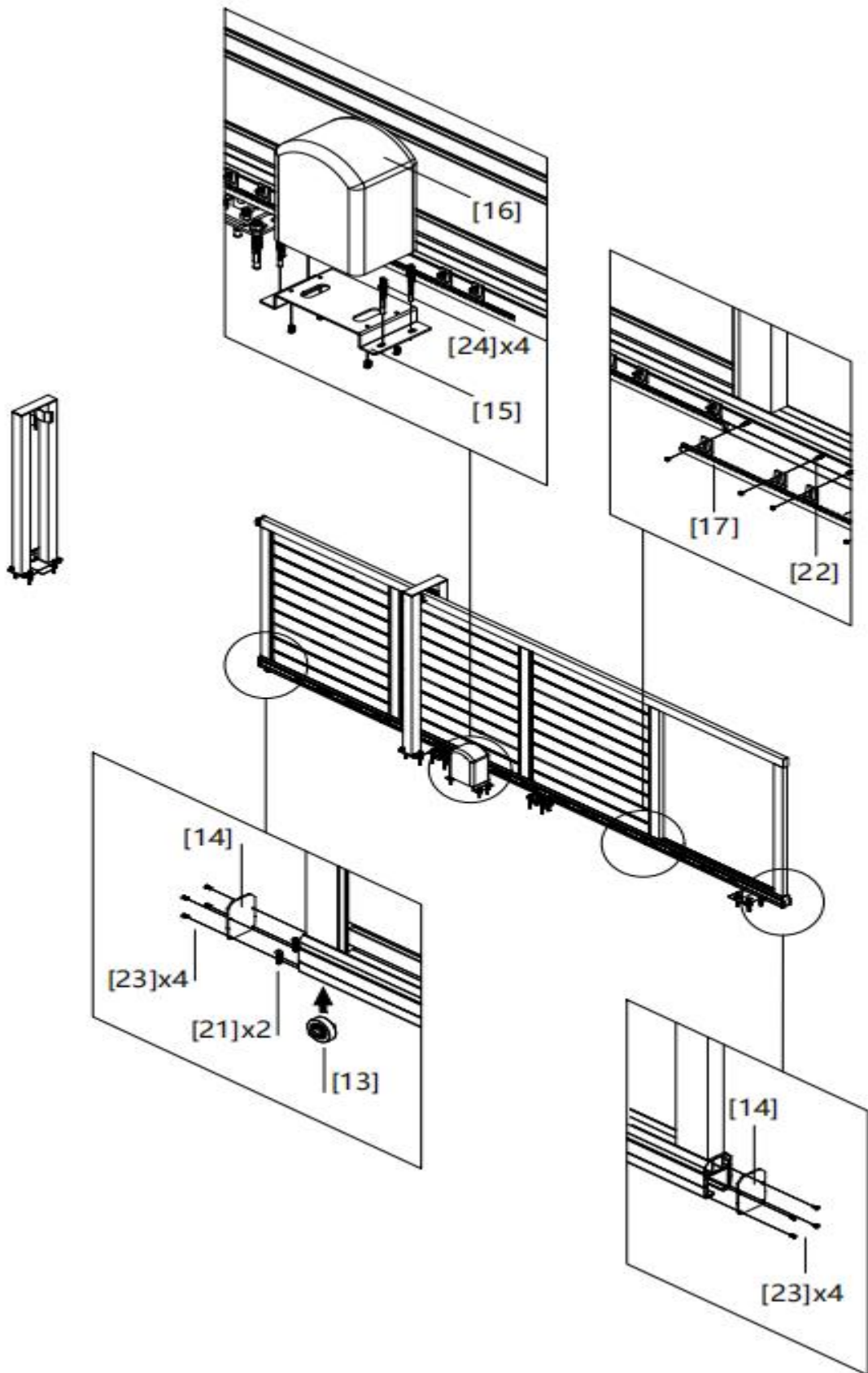

IV. After-sales service and guarantees

For any technical problems and to obtain spare parts, contact the Pre-Sales Service using the following contact details:

After-sales service Virtuoso :

- By email: comenzi@stift.ro
website : www.virtuoso.ro
- By address : Ion Creanga 10, 075100 Ilfov, Otopeni
- Before requesting spare parts, have this notice ready to indicate the number of the part concerned (see parts tables in the nomenclature section).

ATTENTION



Do not modify the portal. Any modification to the gate voids the warranty.

The warranty does not cover:

- Cases of non-compliance with the conditions of use, care, maintenance and storage described

In this instruction manual;

- Abnormal use of the portal;
- Damage caused by shocks received by the gate;
- Installation of the gate that does not comply with these instructions;
- Use of spare parts not supplied by the Virtuoso pre-sales service;
- A malfunction following a modification of the portal

Cuprins

Introducere

I. Dimensiuni

II. Unelte necesare

III. Ghid de asamblare

1. Lista de piese

2. Instrucțiuni de asamblare

IV. Serviciul post-vânzare și garanții

INTRODUCERE

Acesta poarta este conceputa pentru uz casnic, cu excluderea oricărei utilizări comerciale sau de afaceri.

INSTRUCȚIUNI DE SIGURANȚĂ, MEDIU ȘI LEGISLATIE

INSTRUCȚIUNI DE SIGURANȚĂ ȘI DE MEDIU

NERESPECTAREA AVERTIZARILOR DIN ACEST MANUAL POATE PROVOCA RĂNIRI FOARTE GRAVE ȘI/SAU DSITRUGEREA PORȚII.

Pentru a face mai ușor de înțeles instrucțiunile de siguranță, în acest manual sunt utilizate următoarele simboluri:



Acest simbol de AVERTISMENT indică acțiuni sau comportamente care ar putea duce la o situație periculoasă sau la contactul cu organe de asamblare periculoase care ar putea cauza răni foarte grave.



Acest simbol „ATENȚIE” indică puncte importante care ar putea duce la deteriorarea porții dacă nu sunt respectate.

VERIFICARI SI SFATURI INAINTE DE MONTARE



Consultați instrucțiunile înainte de orice asamblare.

Verificați folosind instrucțiunile dacă toate piesele sunt prezente.

- În cazul pieselor lipsă sau deteriorate, contactați serviciul post-vânzare Virtuoso înainte de a efectua asamblarea.
- Aranjați piesele înainte de asamblare prin aranjarea spațiului de lucru pentru a facilita asamblarea.
- Nu montați poarta într-o zi cu vânt.
- Asigurați-vă că există suficient spațiu pentru deschiderea ușilor.
- Asamblarea necesită de preferință 2 persoane cu bune cunoștințe de bricolaj

SECURITATE



Pentru a vă monta poarta în siguranță, utilizați următorul echipament individual de protecție:



Căști cu anulare a zgomotului



Mănuși



Pantofi



Ochelari

I.DIMENSIUNI

Lungimea portii: 590cm

Inaltime poarta: 180cm-200cm

Spațiu minim între stâlpi: 450cm

Înălțimea minimă a stâlpului: 196cm-216cm

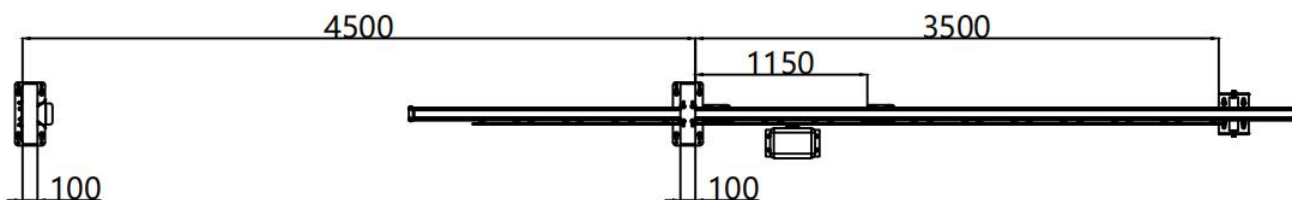

ATENȚIE

Daca doriti sa iti motorizezi poarta este imperativ sa tii cont de specificul instalarii motorizarii in pozitionarea portii tale si asta inainte de a-ti monta poarta.

I.DIMENSIUNI

POZIȚIONAREA PORTII INTRE STALPI:

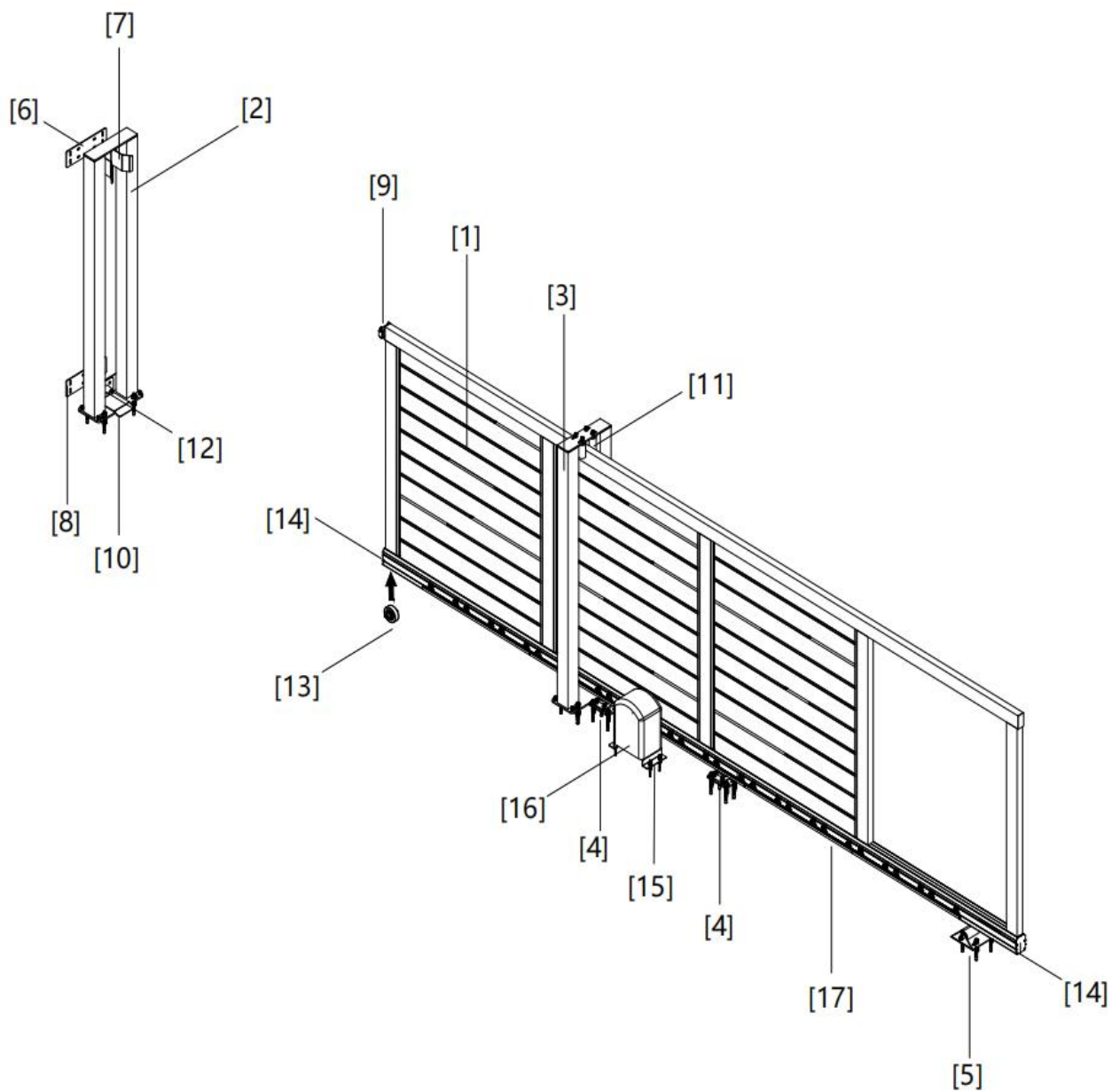

II. Unele necesare

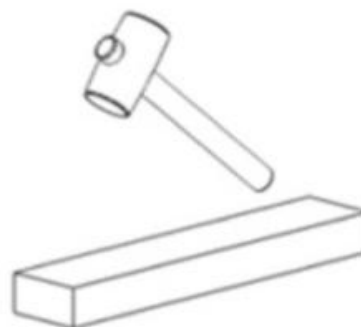
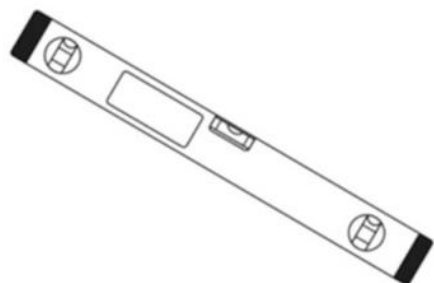
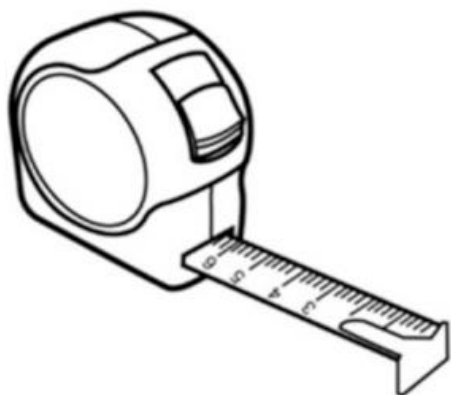

III. Ghid de asamblare

1. LISTA COMPONENTE

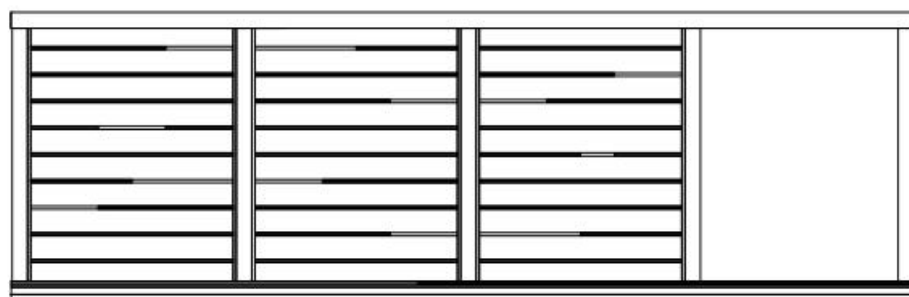

[1]



[2]



[3]



[4]-2



[5]

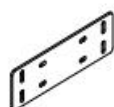

[6]



[7]-2

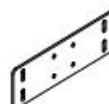

[8]



[9]



[10]



[11]-4



[12]



[13]



[14]-2



[15]



[16]



[17]



[18]-20
M16×150



[19]-8
M10×40



[20]-20
M10×30



[21]-5
M8×30



[22]-30
M6×16



[23]-8
M5×15



[24]-4
M10×120

2. Instrucțiuni de asamblare

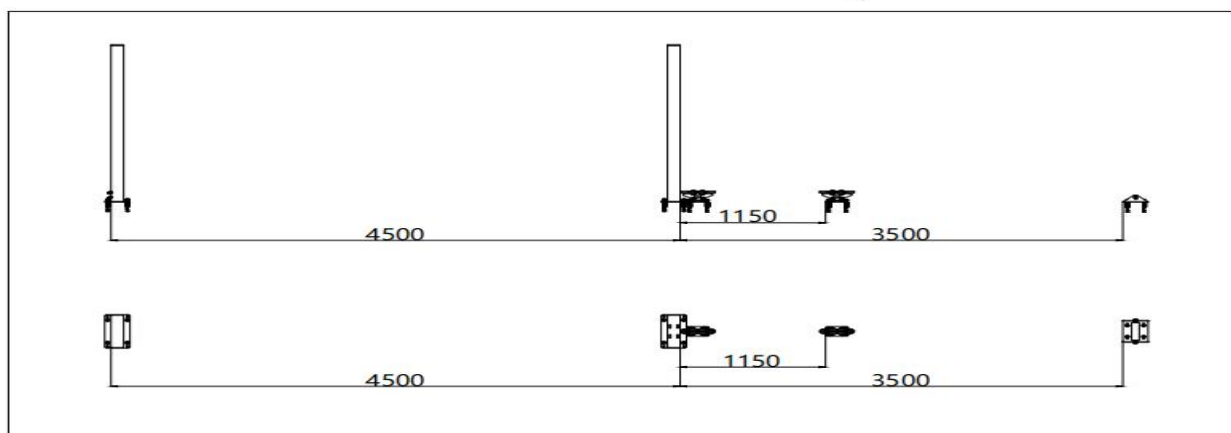
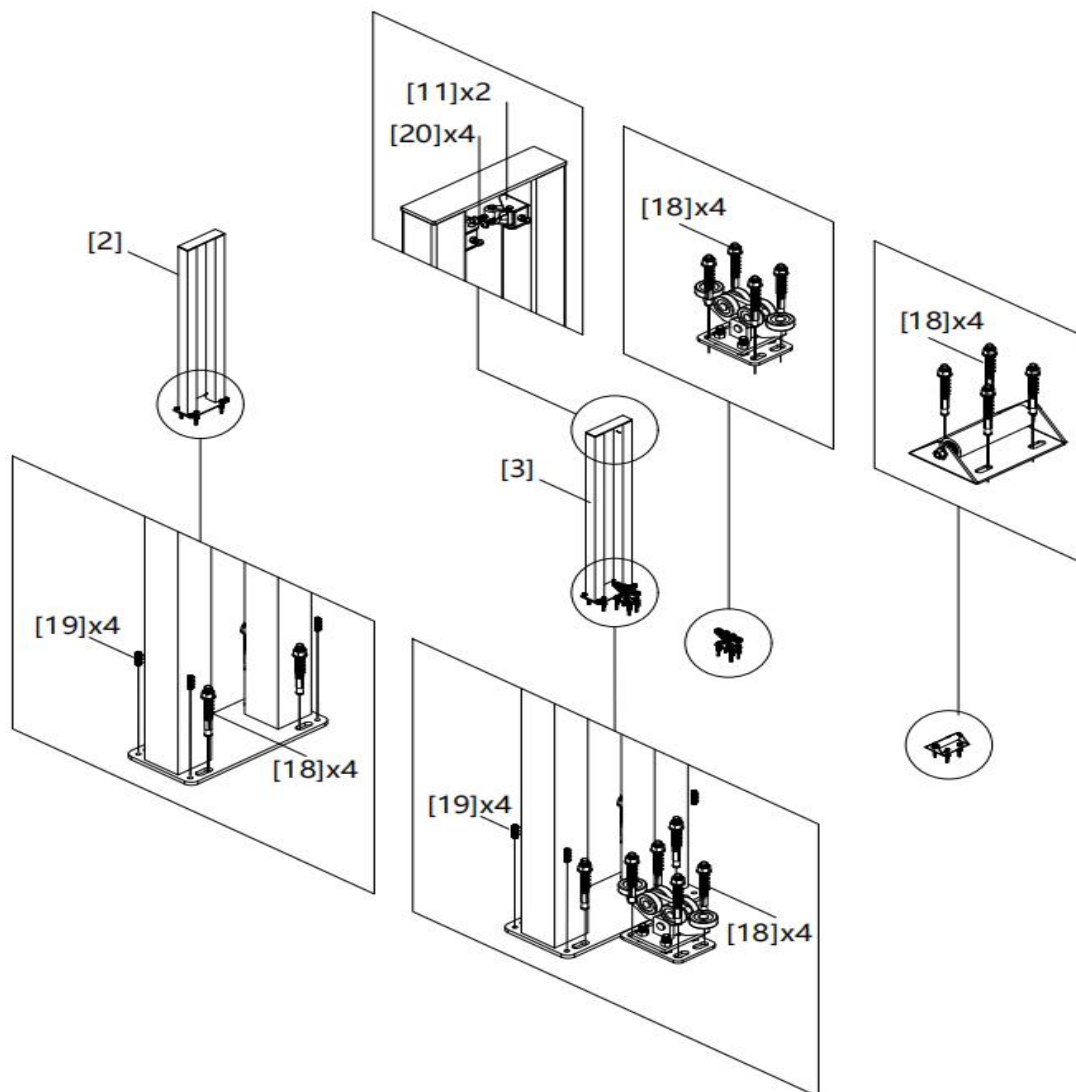

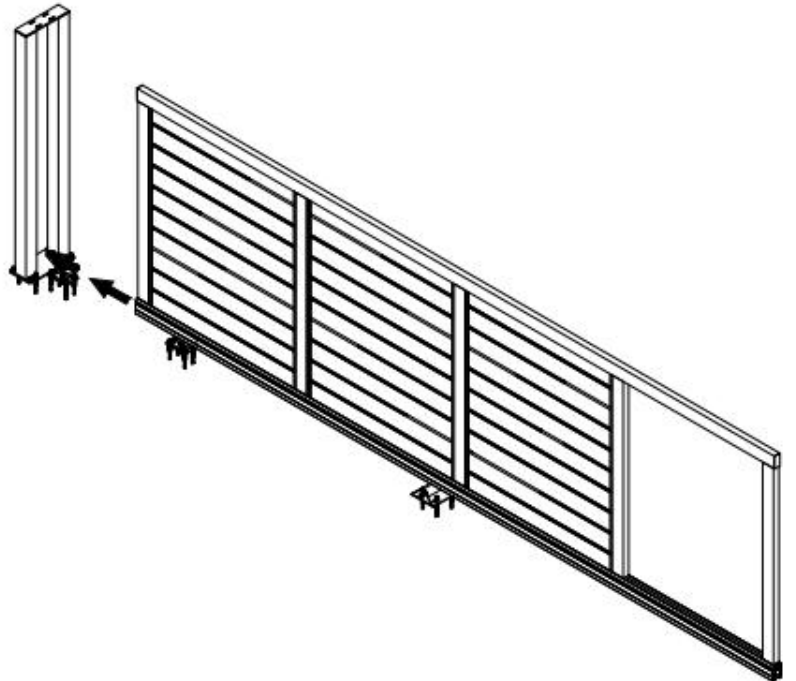
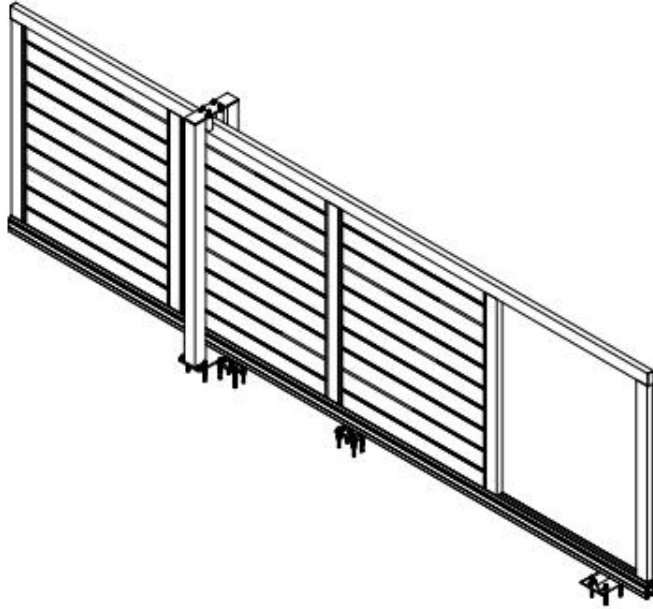
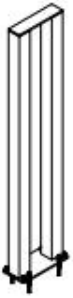

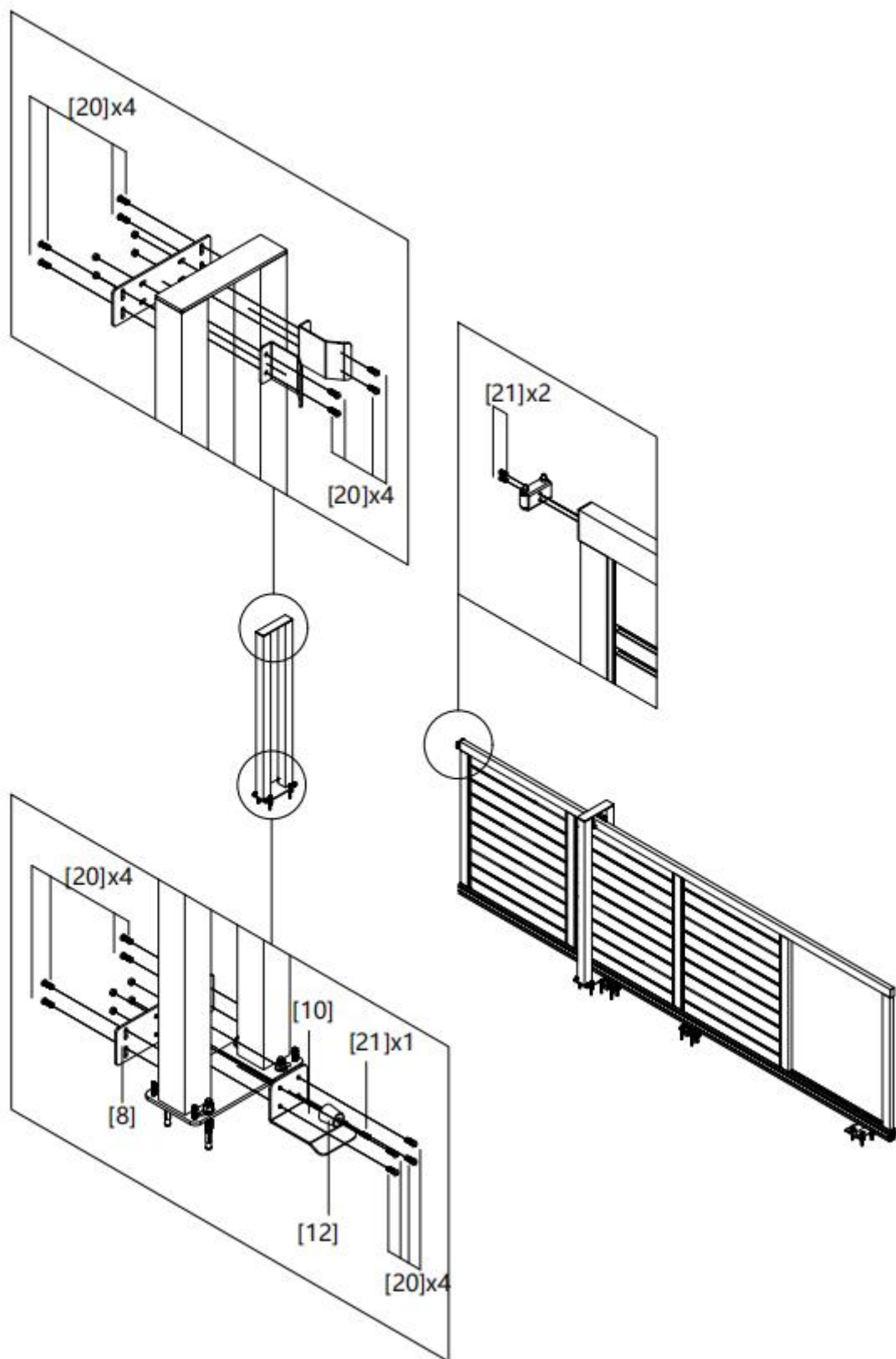

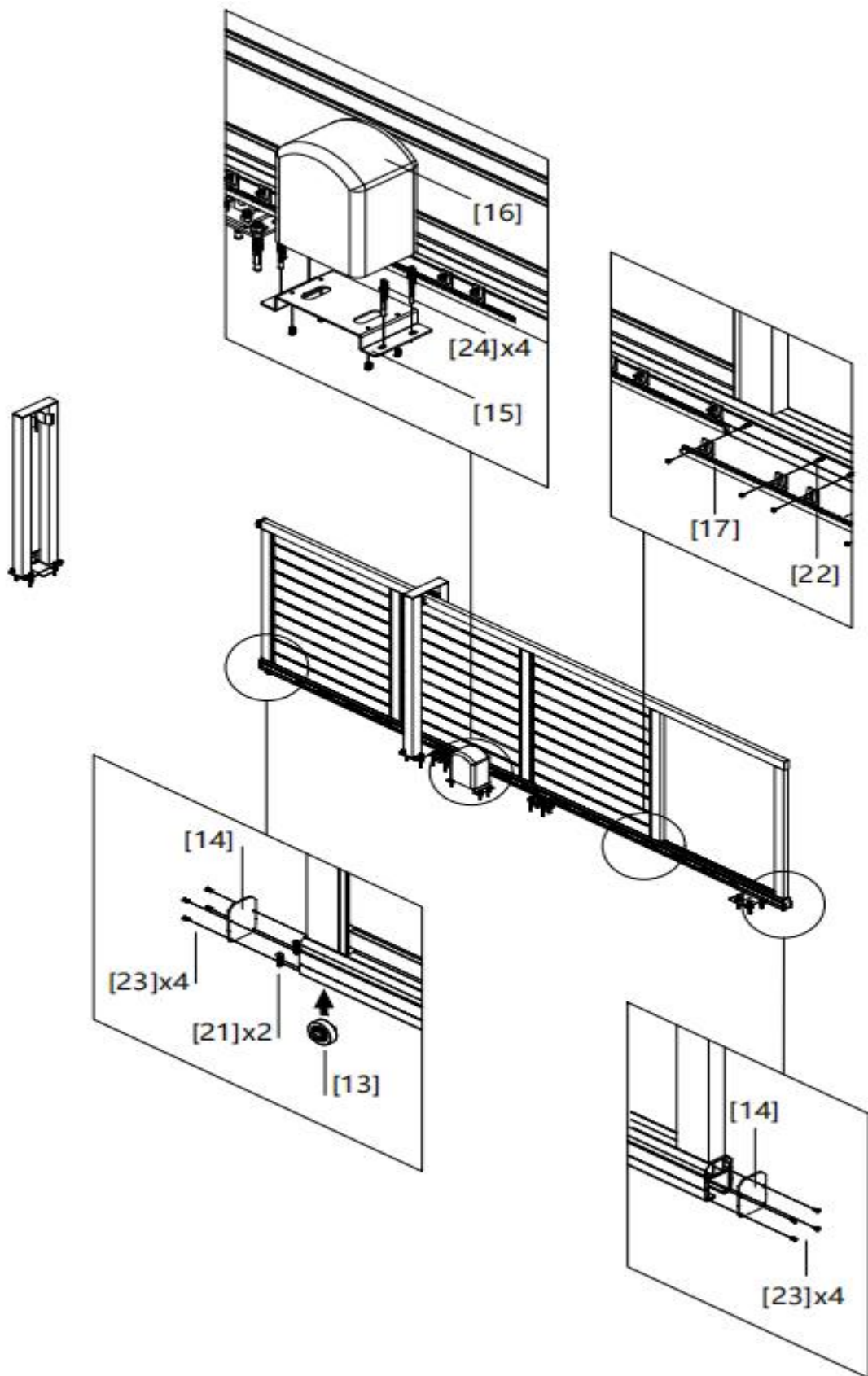

IV. Serviciul post-vânzare și garanții

Pentru orice probleme tehnice și pentru a obține piese de schimb, contactați Serviciul Pre-Vânzare folosind următoarele date de contact:
Serviciu post-vânzare Virtuoso:

- By email: comenzi@stift.ro
website : www.virtuoso.ro
- By address : Ion Creanga 10, 075100 Ilfov, Otopeni
- Înainte de a solicita piese de schimb, aveți la dispoziție această notificare pentru a indica numărul piesei în cauză (vezi tabelele de piese din secțiunea nomenclatură).

ATENȚIE



Nu modificați portalul. Orice modificare adusă porții anulează garanția.

Garanția nu acoperă:

- Cazuri de nerespectare a condițiilor de utilizare, îngrijire, întreținere și depozitare descrise în acest manual de instrucțiuni;
- Utilizarea anormală a porții;
- Daune produse de socurile primite de poarta;
- Montarea porții care nu respecta aceste instrucțiuni;
- Utilizarea pieselor de schimb nefurnizate de serviciul de pre-vânzare Virtuoso;
- O defecțiune în urma unei modificări a porții